



Air Cooler **INSTRUCTION MANUAL**

Read this manual carefully before operation

Pictures in this manual are for reference only, the product in kind prevail.



**TORNADO 54TR
TORNADO 70TR**

This instruction manual contains important information & recommendations that we would ask you to comply with to obtain best results from your products.

THANK YOU



Congratulations on your purchase of this versatile CG Evaporative Air Cooler. For optimum cooling from your cooler, fill the water tank to maximum level before you turn on your air cooler.

Cooler Location (Important - Please Read!)

Place the cooler in front of an open door or window. Ensure that there is adequate cross-ventilation in the room by leaving a door or window open opposite the cooler. Following these guidelines will ensure your cooler will work as effectively as possible. Keep distance of minimum 0.5 meters from the wall.

Not an Air Conditioner (Important - Please Read!)

The evaporative air cooler is not an air conditioner as it does not use a compressor or refrigerant gas. It should not be expected to cool as efficiently as a refrigerated air conditioner.

Read all instructions carefully before setting up and operating the cooler, and please keep this instruction manual for future reference. This manual is designed to provide you with important information needed to setup, operate, maintain, and troubleshoot your cooler. Failure to follow these instructions may damage and/or impair its operation and void the warranty

SECTION	PAGE
User Tips	4
Safety	6
Parts Description	8
Uses and Operation	10
Cleaning & Maintenance	14
Troubleshooting Guide	16
Electric Wiring Diagram	17

QUICK START GUIDE

Fill the tank with water and plug the cooler in standard power outlet socket.

Note: Please make sure the household power voltage matches the product specifications.

Place near an open door or window.

Note: Evaporative air cooler requires cross ventilation.

Turn ON and enjoy the cooling breeze.

Note: Start with low speed and gradually increase to higher speed for optimum cooling performance.

Energy efficient, No compressor

CG Evaporative Air Coolers are built to maximize energy efficiency and keep costs low. Warm air is drawn into the cooler through the Cooling Media.

Water pumped from the tank pours over the Cooling media. As the warm air passes through the Cooling media, the water absorbs the heat, naturally cooling and humidifying the air. A fan propels the cooled air out into the room. This no-compressor system cools naturally, efficiently and inexpensively.

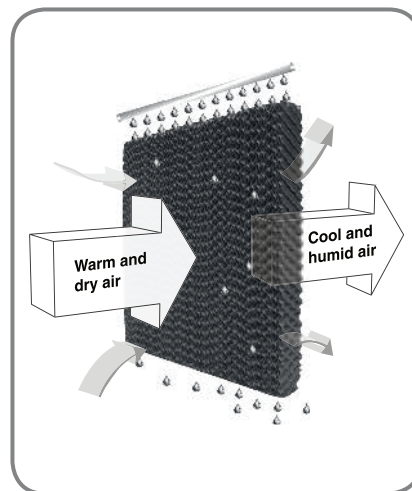
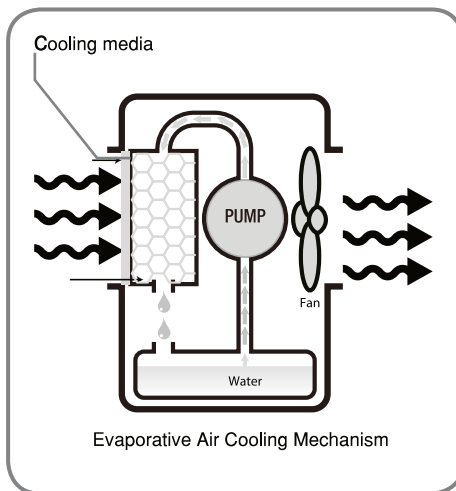

The recommended maximum relative humidity level is 60% or less, which allows a noticeable temperature decrease. The temperature decrease will be greater in drier climates because higher evaporation occurs when the humidity is low.

The evaporative air cooler should not be used in enclosed spaces. It must be kept level and there must be water in the water tank. The room should have doors and windows opened to allow free air flow. The evaporative air cooler works best when placed near an open window, so that outside air is drawn into the evaporative air cooler, the air circulates in the room, then exits via the door. The maximum cooling effect is felt when a person is in the flow of air coming out of the evaporative air cooler.

NOTE

When the product is used for the first time the Honeycomb cooling media will have an odor which will dissipate in a week or so of initial use



Room with open windows & door
(RECOMMENDED)



Room with closed windows &
door (NOT-RECOMMENDED)

*Image for illustration purpose only may vary from actual model

READ AND SAVE THESE INSTRUCTIONS:

When using electrical appliances, basic safety precautions should always be followed:

- Your cooler runs on 230 Volt AC, 50 Hz. Check the household voltage to ensure it matches the appliance's rated specification.
- Before operating the product remove it from its packaging and check that it is in good condition.
- DO NOT operate any product with a damaged cord or plug. We recommend not using an extension cord with this appliance.
- DO NOT run power cord under carpeting, or cover it with rugs or runners. Keep the cord away from areas where it may be tripped over.
- Always unplug the product before refilling the water tank.
- Always unplug the appliance from the power source before cleaning, servicing or relocating the unit.
- Remove the power cord from the electrical receptacle by grasping and pulling on the power cord plug-end only, never pull the cord.
- DO NOT use the product in areas where gasoline, paint or other flammable goods and objects are stored.
- When using the "COOL" setting, check the water tank to ensure that it is full. Operation of this cooler on the "COOL" setting with an empty tank may result in damage to the water pump.
- DO NOT attempt to repair or adjust any electrical or mechanical functions of the cooler, as this may void the warranty.

*Image for illustration purpose only may vary from actual model



- DO NOT cover the air inlet or outlet on the appliance as this may cause motor damage.
- DO NOT insert or allow objects to enter any ventilation or exhaust opening as this may damage the product and could cause an electrical shock or fire.
- DO NOT operate with the Honeycomb media removed as this will overload and damage the motor.
- DO NOT leave the operating appliance unattended for an extended period of time.
- DO NOT let children play with this appliance, packaging or plastic bags.
- If the unit is damaged or it malfunctions, do not continue to operate it. Refer to the troubleshooting section and seek professional advice.
- Place the unit on a level floor. This product is not intended for use in wet or damp locations.
- DO NOT use in bathrooms. Never locate the product where it may fall into a water container.
- Store in a dry area when not in use. This appliance is not intended for use by persons (including children or elderly) with reduced physical, sensory or mental capabilities, or lack of experience and knowledge, unless they have been given supervision or instruction concerning use of the appliance by a person responsible for their safety.
- Always grip the side handles to move the cooler.
- Do not throw / allow water or any liquid on Electronic control panel of cooler. It may damage the Appliance.

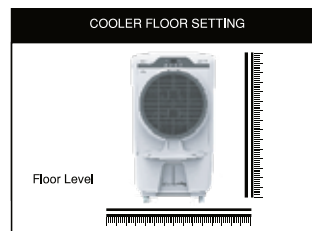
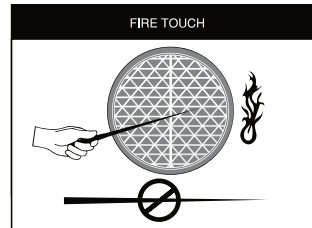

*Image for illustration purpose only may vary from actual model

PARTS DESCRIPTION (MECHANICAL-FAN)

CG

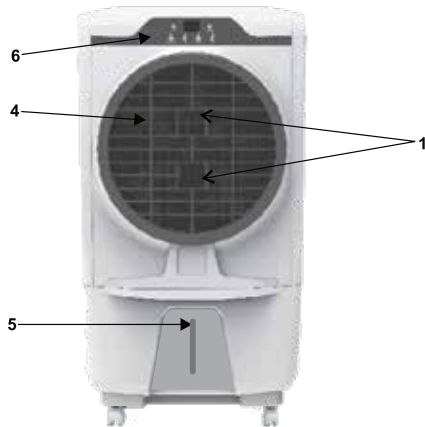

1. Lever for Horizontal Louvers
2. Water Tank
3. Castors (Wheels)
4. Horizontal Louvers
5. Water Level Indicator
6. Electronic Control Panel
7. Back Honeycomb Panel
8. Water Drain Plug
9. Manual Water Filling
10. Rear Grill Removal Screws
11. Handle
12. Side Grill Removal Screws
13. Water Overflow Hole

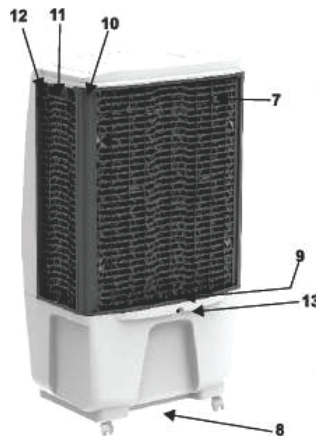

90 Liter Castor Wheel Assembly steps

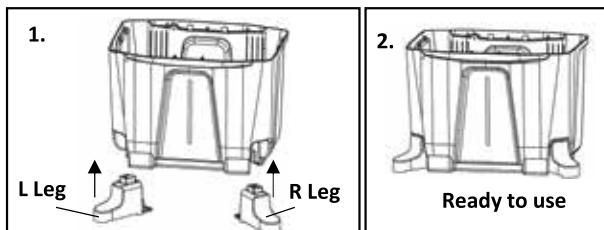

1. Unpack the packing box and take out the cooler along with 2 legs
2. Assemble L leg towards Left side with the help of 2 Screws and screwdriver
3. Same way assemble R leg towards Right side
4. Fix 5 Qty. castor wheels to the cooler and cooler is ready to use

*Image for illustration purpose only may vary from actual model

CONTROL PANEL

CG

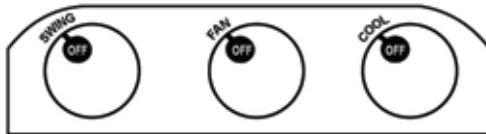

Swing Vertical Louvers Knob

Turn the switch knob to ON. The Louvers will begin to move from right to Left automatically

Fan Speed selection Knob

Connect to the power supply and turn the Fan knob. The fan will start. Turn the knob to "High" for High speed, to "Medium" for Medium speed and to "Low" for Low speed. To switch the fan OFF, turn the Fan knob to "OFF" position.

Cool (Pump) On/Off knob

Turn the switch knob to ON. the Pump

SWING Knob



FAN Knob



COOL Knob

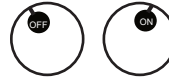

PARTS DESCRIPTION (ELECTRONIC)

CG

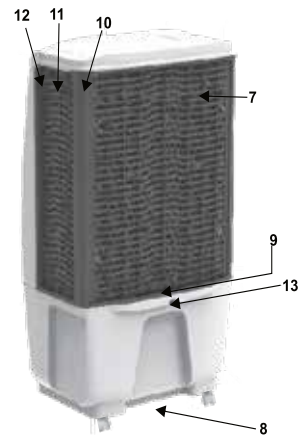
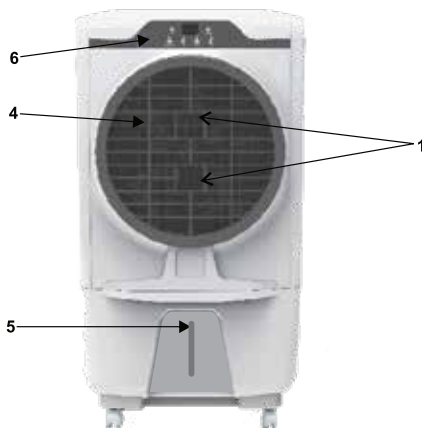

1. Lever for Horizontal Louvers
2. Water Tank
3. Castors (Wheels)
4. Horizontal Louvers
5. Water Level Indicator
6. Electronic Control Panel
7. Back Honeycomb Panel

8. Water Drain Plug
9. Manual Water Filling
10. Rear Grill Removal Screws
11. Handle
12. Side Grill Removal Screws
13. Water Overflow Hole

*Image for illustration purpose only may vary from actual model

DISPLAY:

There are 8 LED's on the Receiver board (Front display panel) to indicate the following functions:-

- ≠ Power :
To indicate supply in system. This led glow in standby condition.
- ≠ Cool :
To indicate the pump on/off condition.
- ≠ Tank Alarm* :
To indicate the tank full/empty condition.
- ≠ Fan Speed :
To indicate fan speed (low, medium, high).
- ≠ Timer:
To indicate timer is active or not.
- ≠ Swing:
To indicate swing is active or not.
- ≠ Smart Humidity *
To Indicate Smart Humidity Mode on/off Condition.
- ≠ ECO COOL :
To indicate ECO Cool mode on/off condition.

DUAL DIGIT DISPLAY*:

Dual Digit display is used to Indicate the following functions -

- 01,02,04,08 : Timer value in case of timer is active (only for five second).
- F1, F2, and F3 : To indicate fan speed low, medium & high
- 't X x' : To indicate current temperature *
- 'h X x' : To indicate relative humidity *

* in selected model only

USE & OPERATION (ELECTRONIC)

CG

CONTROL PANEL: SMART HUMIDITY



CONTROL PANEL: TOUCH

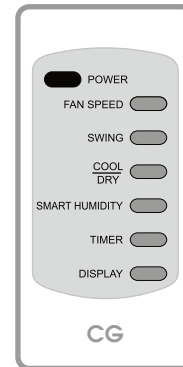

SMART HUMIDITY REMOTE

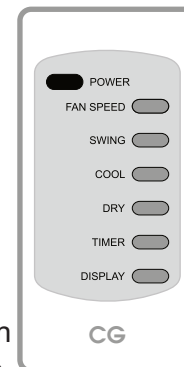

TOUCH REMOTE

General Features: -

The Air Cooler model has following general features:-

- Display – Dual digit display with 8 led indicators.
- Different fan speed i.e. low, medium and high.
- Memory backup in case of power failure.
- Timer can be set in hour to turn the system on/off.
- Smart Humidity Mode* : For balanced cooling.
- ECO COOL mode to save water and power consumption
- Pre-Soak mode to Pre-cool the honeycomb pads before starting the fan, releasing cool & fresh air

Note:

The remote control requires AAA (2 x 1.5V) batteries for replacement.

Open the battery compartment at the back of the remote control and insert the AAA (2 x 1.5V) batteries inside. Care must be taken to insert the batteries according to the correct polarity (+/-) markings shown inside the battery compartment

Always point the remote control signal transmitter towards the unit when operating.

Make sure that the signal path is not obstructed.

Remove the batteries if the unit is not going to be used for an extended period of time.

Do not drop the remote control. Do not mix different types of batteries such as alkaline, carbon-zinc, or rechargeable batteries.





Do not mix old and new batteries.

Exhausted batteries are to be removed from the product.

* in selected model only

Transmitter/receiver key features: -

Various keys & the function associated with them are as follows:-

- ≠ **POWER :**  Pressing the power key, the unit turns to on or off.
- ≠ **FAN SPEED :**  Press the fan speed key repeatedly to change the speed between low Medium and High. The indicator light and dual digit display will show the fan speed.
- ≠ **SWING :**  Press the swing key to turn on/off the swing motor. If swing motor is on, its led indicator will illuminate. If swing motor is off , its led indicator will be off. **Note:** For vertical Air flow user can manually adjust the louvers.
- ≠ **COOL:**  Pressing the cool key, pump motor and cool led will get on.
- ≠ **DRY :** Pressing the dry key, pump motor and cool led will get off.
- ≠ **TANK ALARM :**  If water tank is empty, it is sensed by float switch. At this state pump will turn off automatically. Tank led will blink to indicate tank empty state. At this stage buzzer will beep once in every 10 Second (NOTE: buzzer will beep only in cool mode). To reset buzzer press tank alarm key from Receiver (cooler display).
- ≠ **SMART HUMIDITY :** Pressing the smart humidity key, the unit goes into balanced cooling mode.

•TIMER

- Timer can be selected (in hour) to turn on/off the system.
- Timer (in hours) can be selected as –

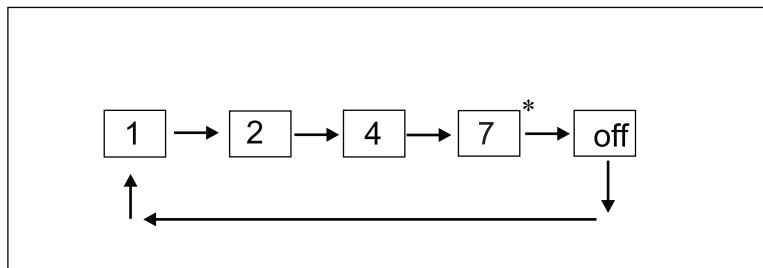

* 6 hours in case of Touch model

Note: While timer is enabled and mains power reset occurs, then timer will get disabled.

Display* : Pressing the display key, make the display on/off

• ECO COOL :

Pressing the ECO Cool key, pump motor will automatically turn On & off as per predefined periodic cycle.

• PRE-SOAK:

On Power ON in cool mode, it will turn on the pump motor first for few seconds before starting the Fan. It is a default feature.

CAUTION :

Unplug from power when refilling the water.

FILLING WATER(Manual) :

Do not over fill the tank

* in selected model only

IMPORTANT

- The cooler is supplied with Cooling Media.
- The cleaning frequency for the Cooling media depends on local air and water conditions. In areas where the mineral content of water is high, mineral deposits may build up on the Cooling Media and restrict air flow.
Draining the water reservoir and refilling with fresh water at least once a week will help reduce mineral deposits. If mineral deposits remain on the Cooling media, the media should be removed and washed under fresh water. The media should be cleaned every two months or sooner, depending on your needs.
Do not run the unit in COOL mode with stale water in the tank. Empty the tank and refill it with fresh water if the water has been standing in the tank for an extended period of time.
- For best results, allow the Cooling Media to dry after each use by turning off the cool function 15 minutes before turning the unit off.
- Draining the water reservoir and refilling with fresh water at least once a week will greatly reduce mineral deposits in the pads and help to extend the life of Cooling Media

WARNING

- Before cleaning the unit, switch it to the “off” position and remove the plug from the power socket.
- To clean the outside, use a damp cloth to remove dirt and dust.
- Never use corrosive elements or any chemicals to clean this product.
- When the product is not in use, store the unit in a dry place out of direct sunlight.
- Maximum water inlet pressure 0.5MPa

DRAINING AND CLEANING THE WATER TANK

- Turn the power “off” and disconnect the air cooler from the power supply.
- Move the unit to a location where it can be drained. Remove the cap from the water drain plug and allow the tank to empty (see parts description on page 9).
- After you have drained the water tank, please connect the water drain plug to its original position.
- Now refill the water tank up to Max level, wait for 5 min. and then drain the entire water once again. Use clean water for this procedure, so that maximum dust particles and remains are completely removed.
- If your cooler has not been used for a long duration, we advise you to clean the water tank at least 2 times before it is used again.

CLEANING THE COOLING MEDIA

- Turn off the unit, and unplug the power cord from wall outlet Rotate the unit facing the back panel, and locate the Rear Grill
- Removal of Screws (refer page 9., #12). Remove the screws with a screw driver
- Pull the rear grill panel backwards, until it is completely removed. Now, the Cooling Media can be seen. Clean the Cooling media with fresh water.
- Once the cleaning has been completed, assemble the unit as described above.
- Plug into the power supply and turn unit on.

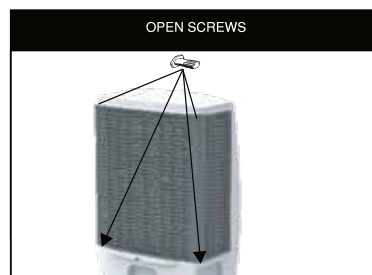

*Image for illustration purpose only may vary from actual model

TROUBLESHOOTING GUIDE



No discharge of air	Cord is not plugged in	Make sure power cord is plugged in and the supply switch is on.
	Power is not on	Turn the unit ON by changing the mechanical knob position of the control panel
	Motor Faulty	Contact Service centre
Not Cooling / Unit is making noise	Pump is not turned ON	On control Panel. Turn COOL FUNCTION TO "ON"
	Low or no water in tank, when COOL is selected	Refill water tank.
	Damaged Pump	Contact service centre.
Odor omission	When the Cooler is new	When the unit is used for the first time, the Cooling Media will have an odor, which will dissipate within a week of initial use. This is normal.
	If the Cooler has been used. There may be an algae issue.	Water is stale Clean the tank and fill with fresh water.
		Clean the Cooling Media.
		If problem persists contact the service centre.

ELECTRICAL WIRING DIAGRAM

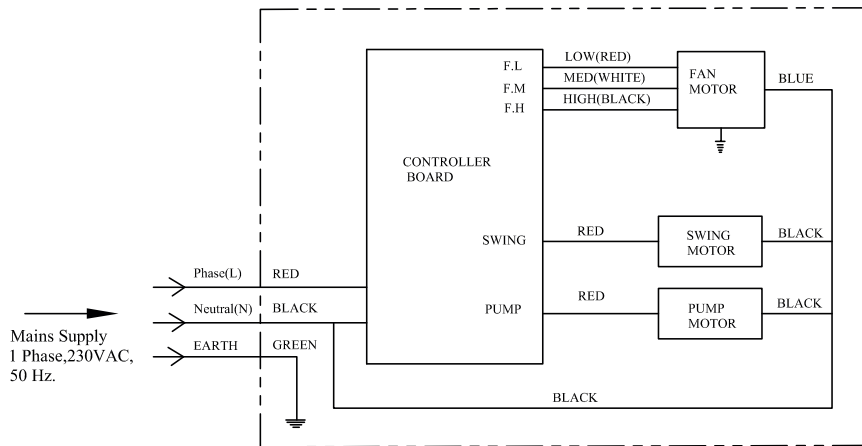

Air Cooler Wiring Diagram (Remote Model)

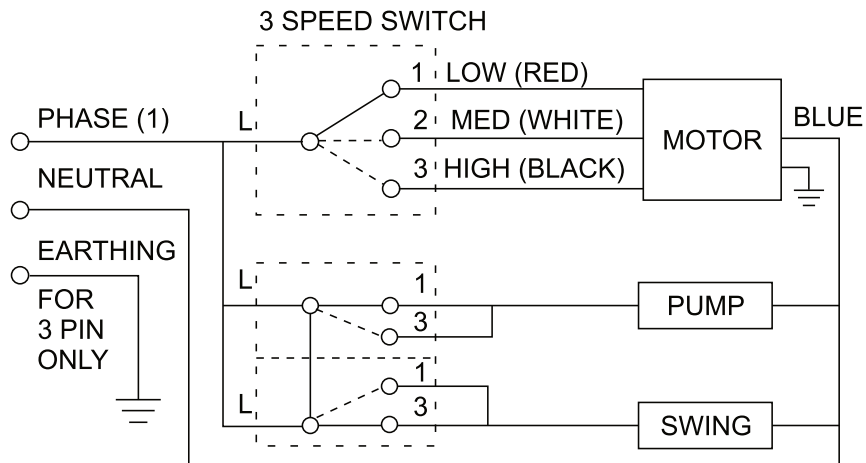

Air Cooler Wiring Diagram (Manual Model)

**A Quality Product
Of**



**IMPORTANT INFORMATION FOR CORRECT DISPOSAL OF THE PRODUCT
IN ACCORDANCE WITH EC DIRECTIVE 2002/96/EC.**

At the end of its working life, the product must not be disposed of as urban waste. It must be taken to a special local authority differentiated waste collection centre or to a dealer providing this service. Disposing of a household appliance separately avoids possible negative consequences for the environment and health deriving from inappropriate disposal and enables the constituent materials to be recovered to obtain significant savings in energy and resources. As a reminder of the need to dispose of household appliances separately, the product is marked with a crossed-out wheeled dustbin.

Visit us at: www.cginspiringlife.com